



SPARE PARTS EXPLODED VIEW
HEAT PUMPS
Model
LYDOS HYBRID

R8217918-03 - 10/01/2018

LYDOS HYBRID

Heat pumps

1	3629052	LYDOS HYBRID 80	09-2017	-
2	3629053	LYDOS HYBRID 100	09-2017	-
Col	Reference	Model type	Begin	End

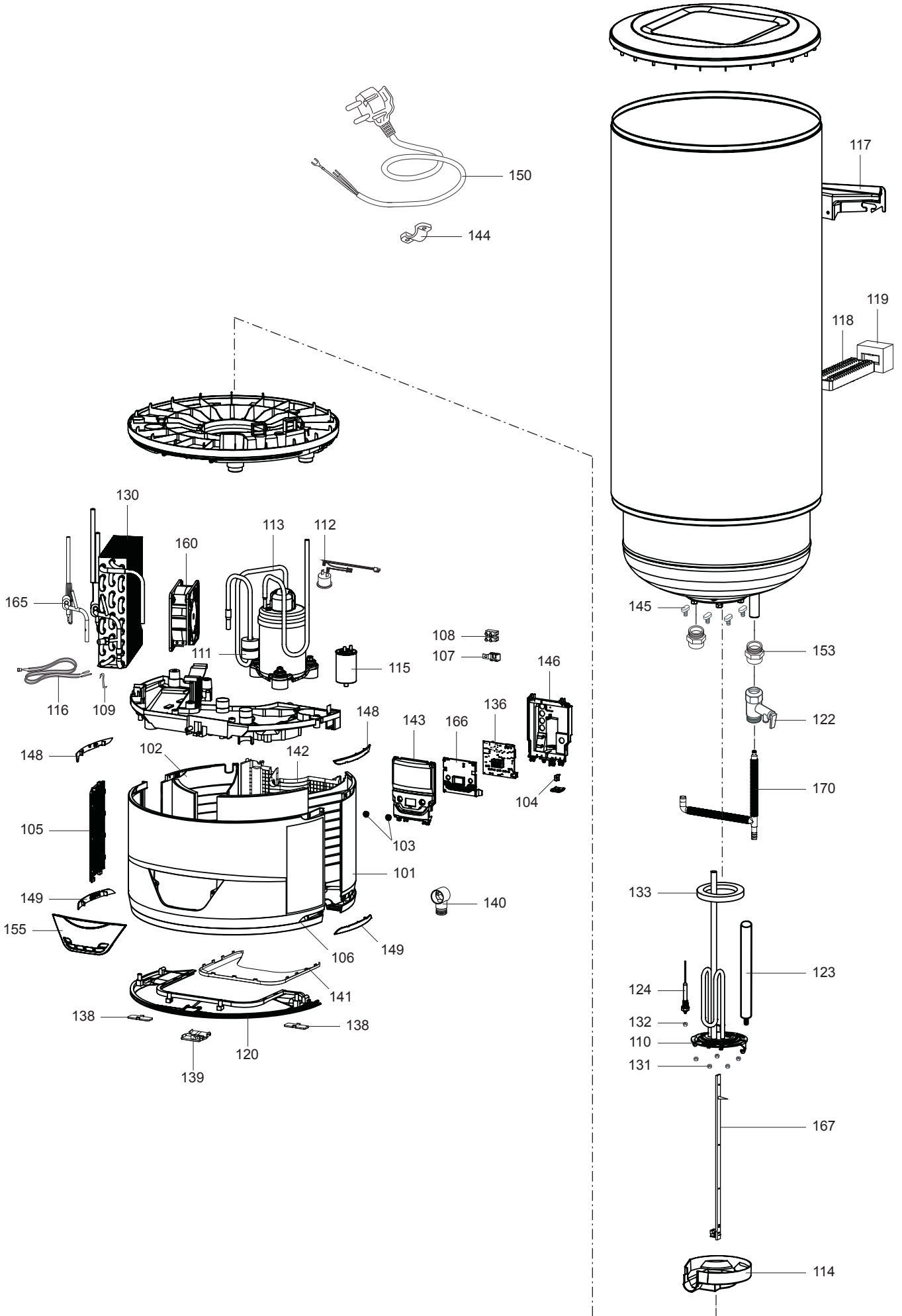

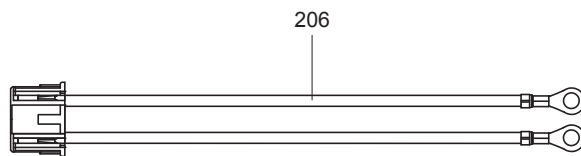
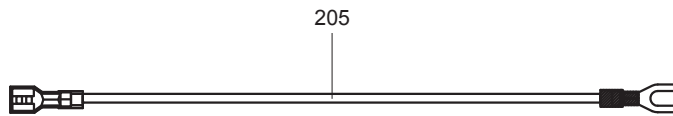
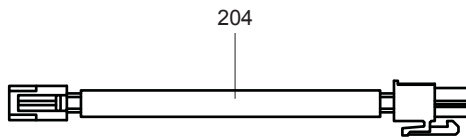
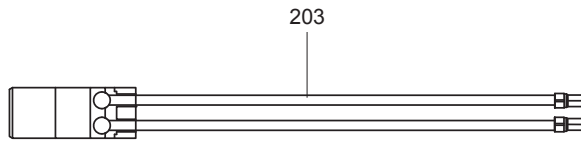
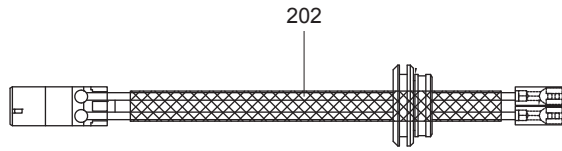
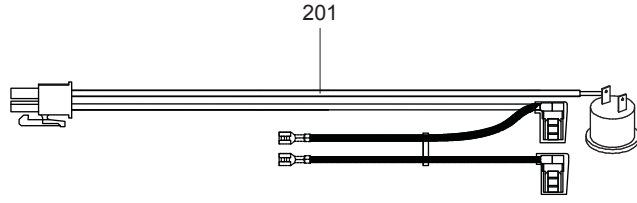

LIST OF THE ABBREVIATIONS

HW	: Hot water.
CW	: Cold water.
C	: Ceramic resistance (normal heating).
Ca	: Ceramic resistance (accelerated heating)
TP	: Immersion heater.
1F	: With fittings.
2F	: Without fittings.
3F	: With fittings and another outlet connection.
AMI	: With mixing valve.
SMI	: Without mixing valve.
PUISS	: Power of th appliance.
PN	: Appliance with normal pression.
LP	: Appliance with low pression.
PV	: Appliance with variable power.
PF	: Appliance with fixed power.

The indications mentioned on the prices, commercial or technical literature and the scheme are written for your guidance and are available at a given time. The CONSTRUCTOR retains the power to modify the presentation, the form, the size, or the conception or the material of the products.
